

# INSTALLATION INSTRUCTION

Waterproof Carport - Portrait  
Concrete Foundation

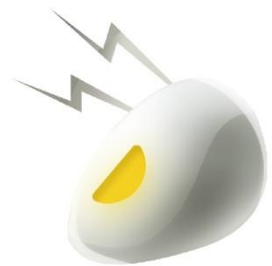

**ANTAI**  
Aluminum & AI Tech for Solar

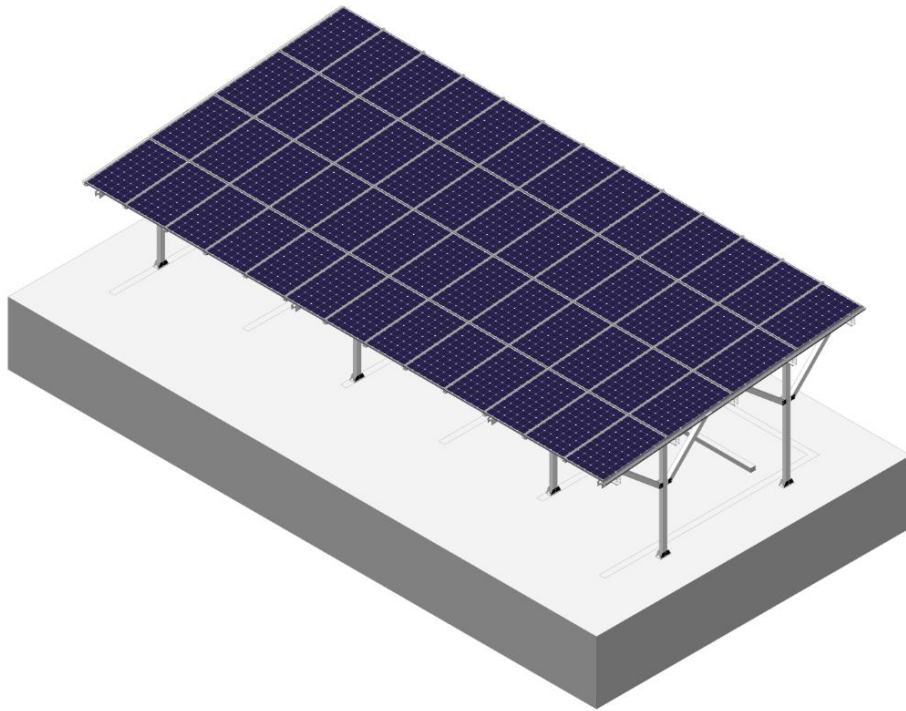

# CONTENT

I. Safety Precautions.....	1
II. Product Introduction .....	2
III. Installation Tools & Equipment.....	2
IV. Components .....	3
V. Installation Instruction.....	4
1. Installation of Concrete Foundation .....	4
2. Torque Value of Bolts .....	5
3. Installation of Pre-assembled Beam.....	6
4. Installation of Rail.....	9
5. Installation of Water Guiding Rail .....	11
6. Installation of Module .....	13
7. Installation of W Rail Top Cover .....	18
8. Each View of Complete Installation .....	19
VI. Notice .....	21

## I. Safety Precautions

Thanks for using Antai solar mounting structure, please follow the installation manual during installation and maintenance.

- General notice

- Installation should be proceeded by professional workers, who will follow the installation manual.
- Please follow the local building standards and environmental protection regulations.
- Please follow the labor safety regulations.
- Please wear the safety gears. (especially helmet, boot, glove)
- Please make sure at least 2 installation workers on site in case of emergency.
- Please bring at least 1 set installation manual to the site.

- When installing at high place, please set up scaffolds to eliminate the risk of falling before proceeding. Please also use the gloves and safety belts.
- Do not modify Antai's products without permission to prevent accidents and malfunctions.
- Please pay attention to the sharp points of aluminum structures and be careful not to be injured.
- Please tighten all required bolts and screws.
- The wire might be damaged when it touches the profile section during electrical wiring work.
- Please do not use the broken, faulty or deformed products in case of danger.

### Requirements





- Please use Antai designated mounting accessories for installation, and do not modify Antai's products in any cases.
- Please do not make strong impact on the profile, while aluminum profile is easy to be deformed and scratched.
- Please note this manual is only for the mounting structures.

## II. Product Introduction

Antai water proof carport is a new highly pre-assembled ground mounting PV system. The special pre-assembled structure and unique beams & rails not only guarantee the whole system stability, but also make installation easier and faster. The high quality, small quantity and highly pre-assembled components greatly save installation time and cost, especially for a large-scale project.

Please read this manual carefully before start installation.

## III. Installation Tools & Equipment

			
6mm Inner Hexagon Spanner	Electric Drill	Measure tape	Marker
			
Torque Spanner	String	Adjustable spanner	Level
			
Box spanner (M12/M16)			

## IV. Components

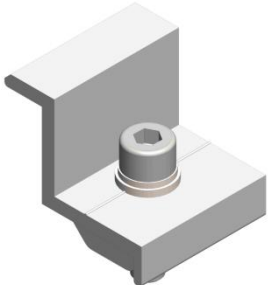
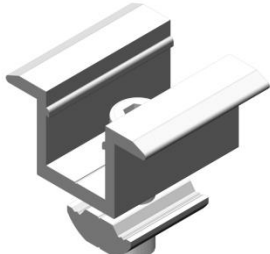
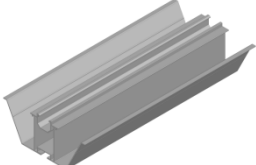
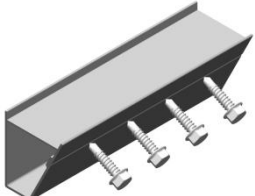
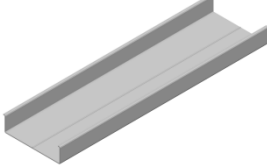
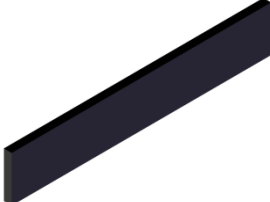
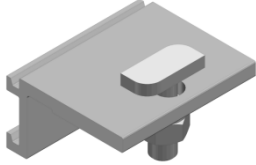
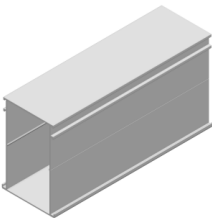
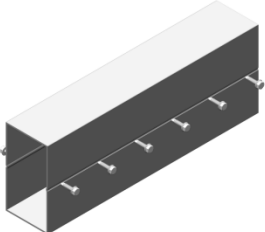
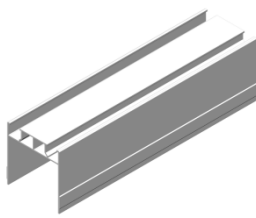
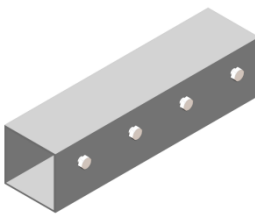
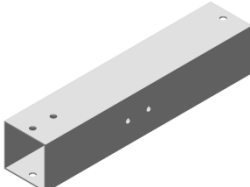
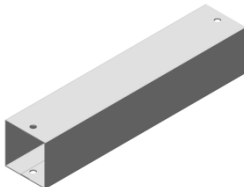
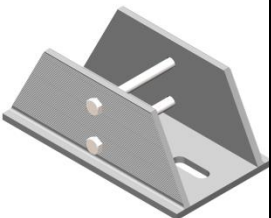
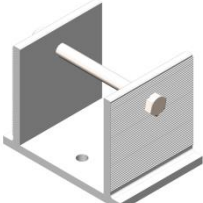
Main Components List			
			
End Clamp	Mid Clamp	W Rail	W Rail Splice
			
Horizontal Water Channel	Rubber String	W Rail Clamp	W Rail Top Cover
			
Bottom Rail	Bottom Rail Splice	Beam	Beam Connector
			
Bottom Rail Clamp	Leg	Bracing	Base
			
U Base	Anchor Bolt		

## V. Installation Instruction

### 1. Installation of Concrete Foundation

Please prepare all necessary tools and products before installation. Firstly, mark the corresponding positions of concrete blocks according to the shop drawing, and bury the anchor bolts in the concrete blocks. The spacing of anchor bolts should follow the hole positions of aluminum base.

- 1.1 Please follow the shop drawing to bury the anchor bolts inside the concrete blocks. (Prepare the layout of concrete foundations beforehand)

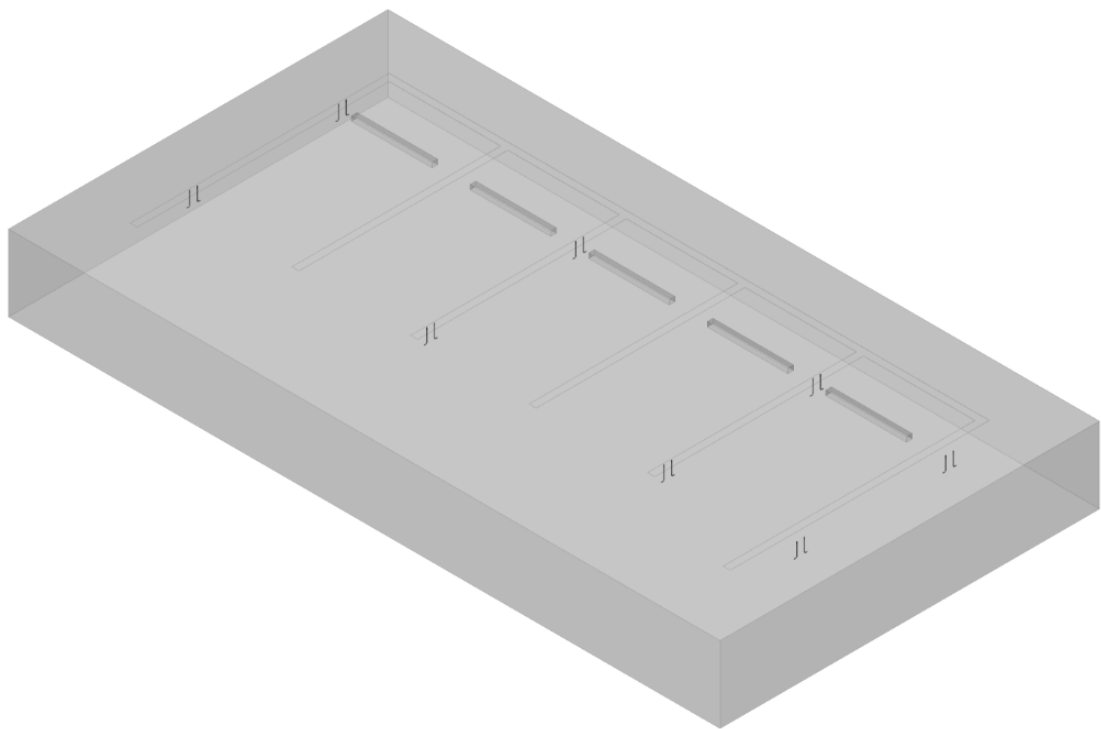

*Layout of Anchors (Flat Ground)*

## 2. Torque Value of Bolts

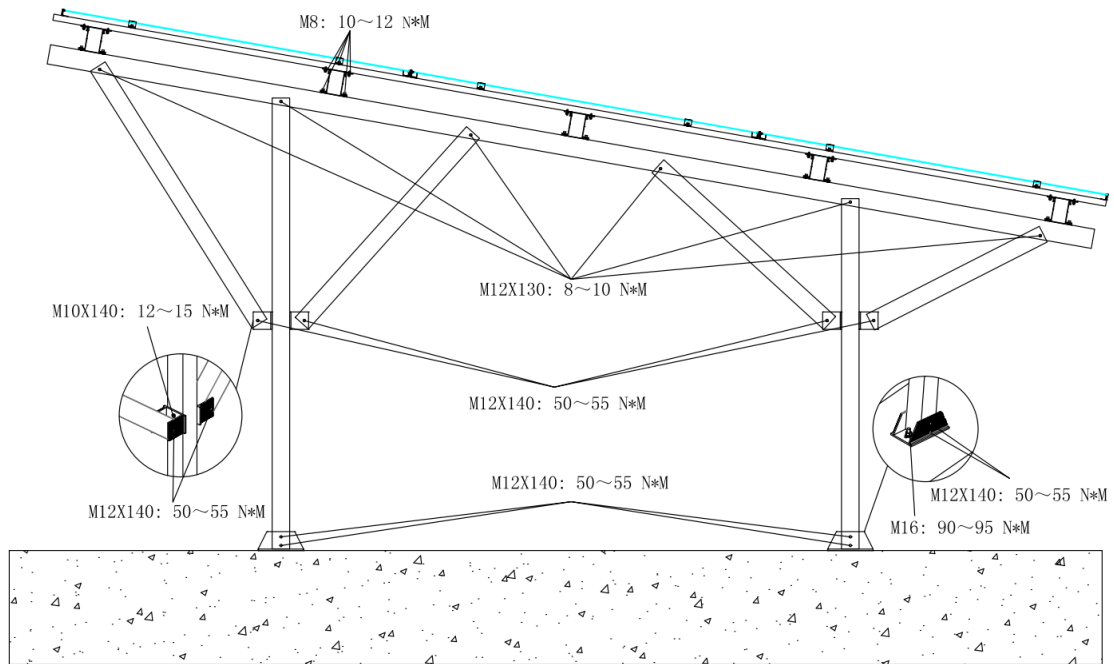

### 【Notes】

- The pre-assembled bolts of the mounting structure are not fully locked, which is convenient for adjustment during field installation. Please make sure all bolts are locked after installation.
- During installation, visually lock the bolts until the spring washer becomes flat.
- During installation, the self-tapping screw should be locked until there is no gap between the transparent plastic washer and the tapping screw head, and also no gap between the tapping screw head and the profile.

### 3. Installation of Pre-assembled Beam

#### 3.1. Connecting 2pcs beams

(Skip this step if the beam is long enough)

Insert the half beam connector to the first beam and tighten the 2pcs bolts, then insert the other side of connector to the second beam and tighten the rest 2pcs bolts.

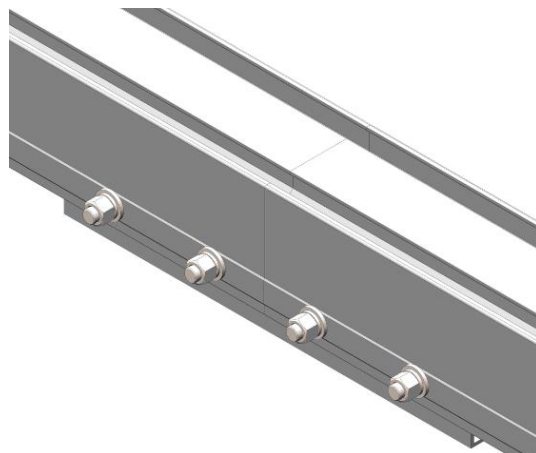
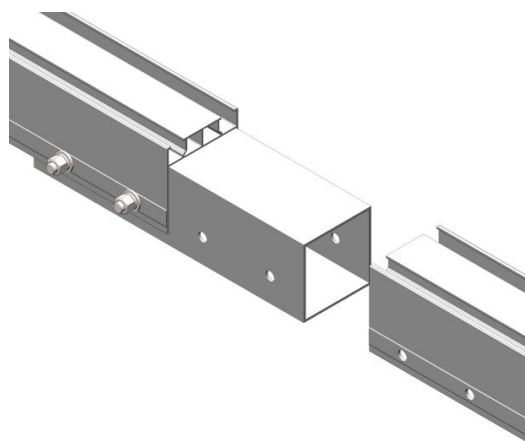
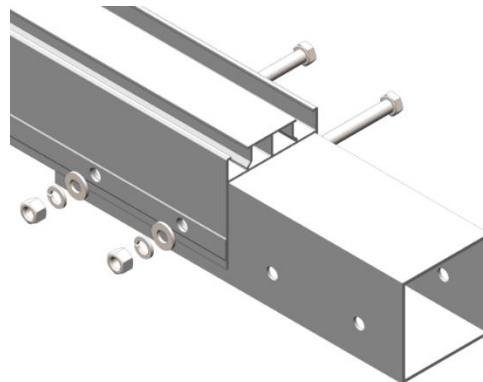



3.2. Connecting legs & bracings to the beam by M12x130 bolts/nuts, and connecting the bracings to legs by U base with M10&M12 bolts/nuts. Then connecting legs to the bottom base, which fixed by the anchor bolts.

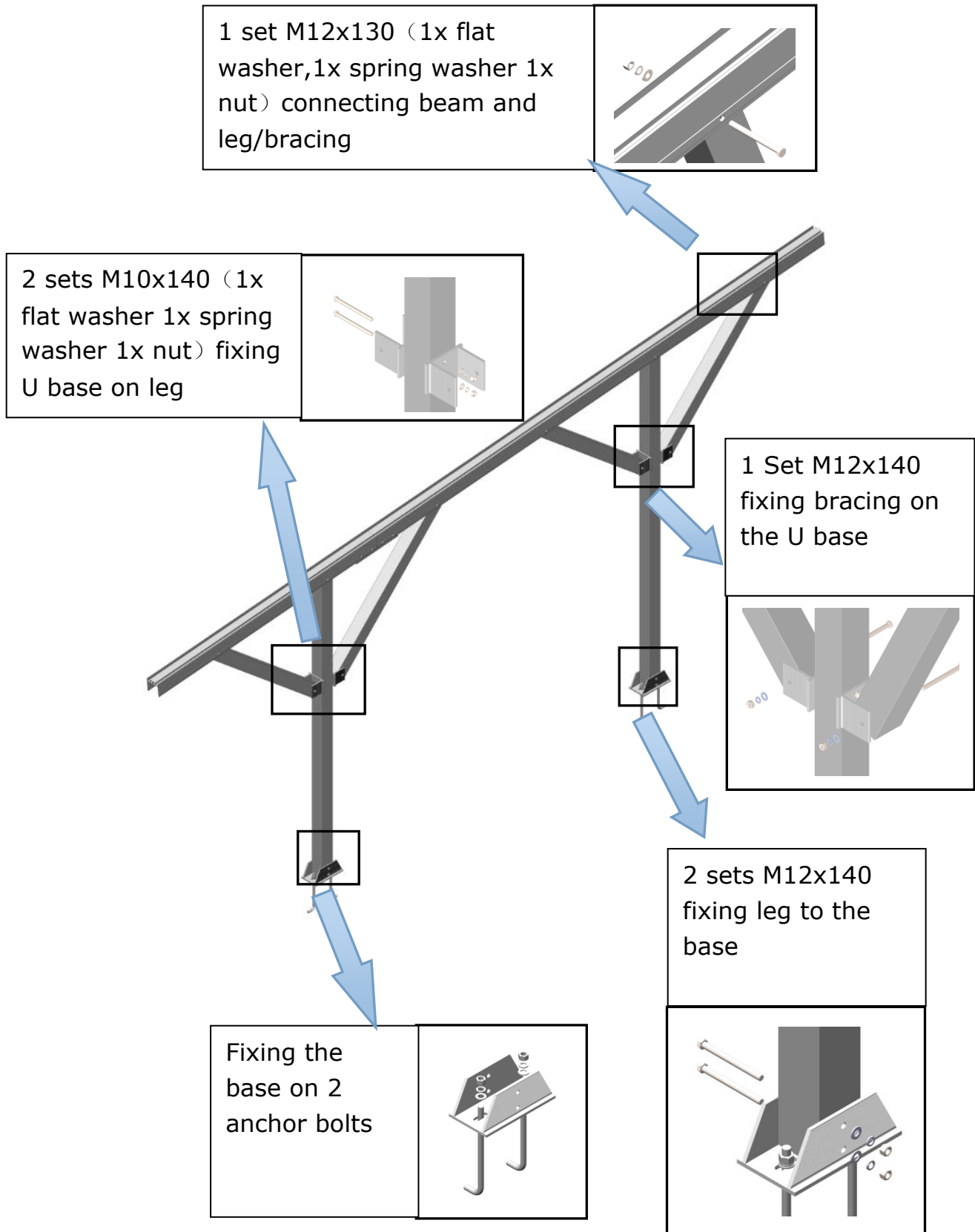

3.3. Repeat above steps to install the structures on the concrete blocks

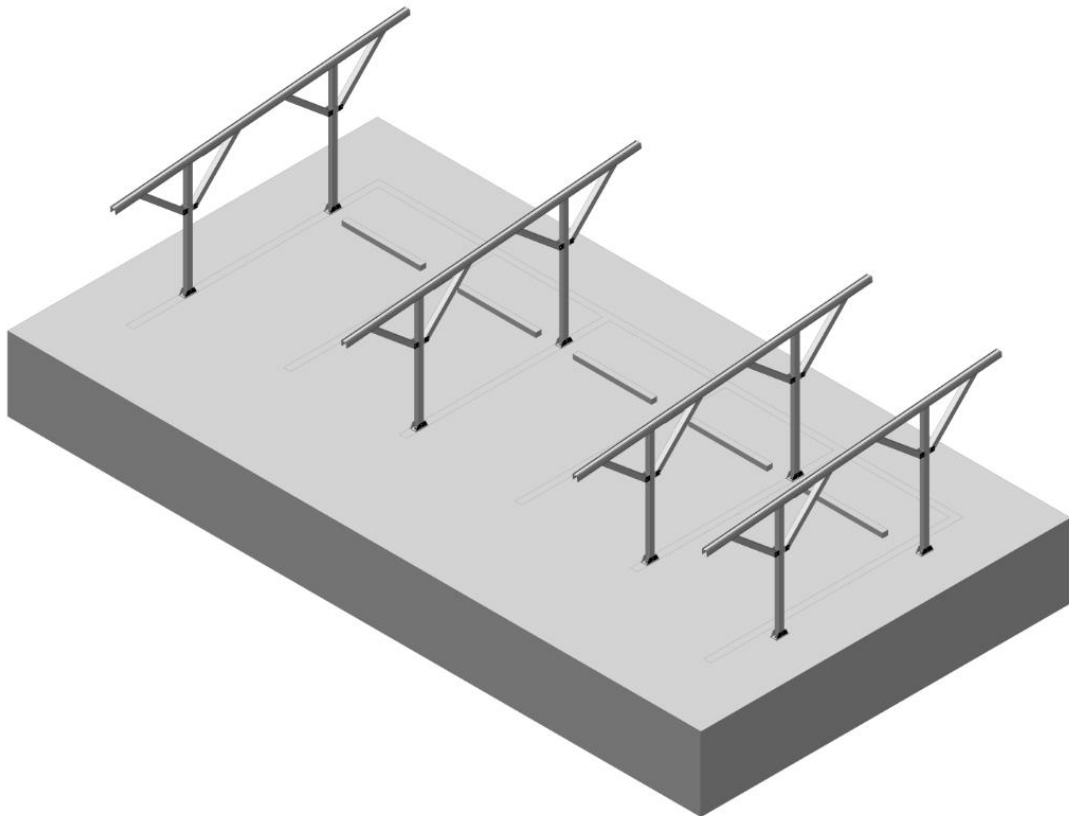

3.4 Please make sure all the support structures on the same plane.

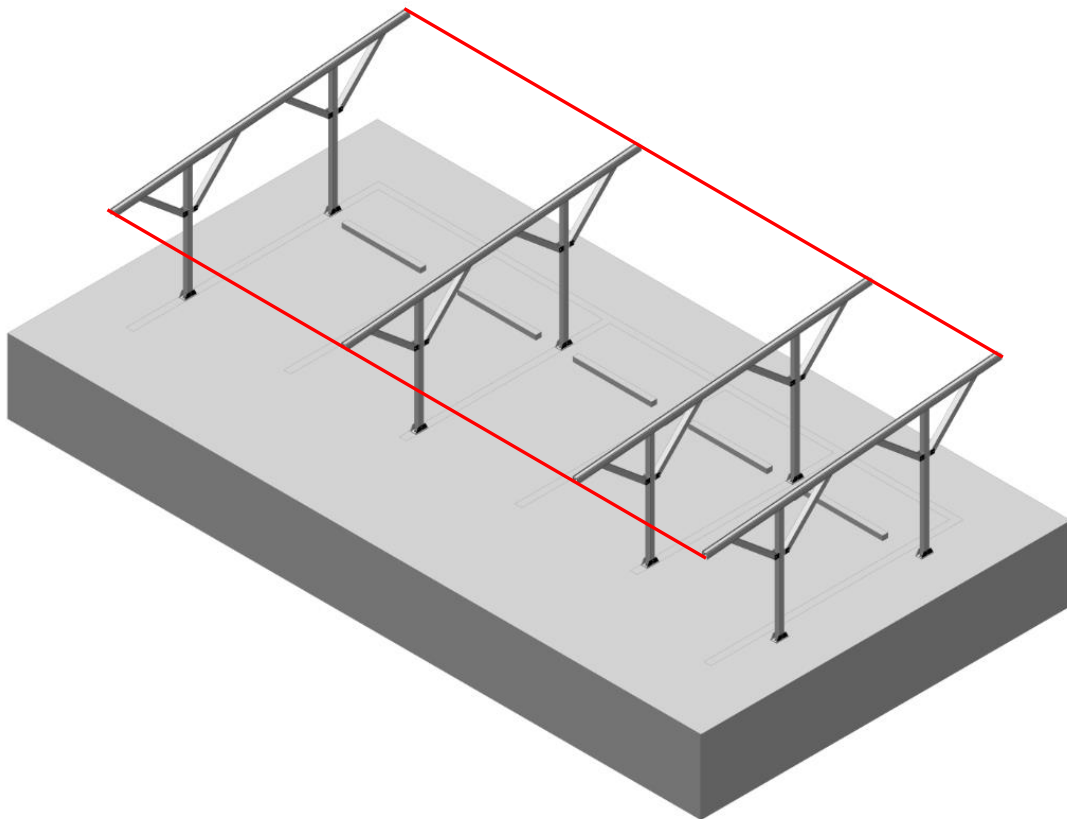

## 4. Installation of Rail

### 4.1. Connecting 2pcs rails

(Skip this step if the rail is long enough)

Insert half rail splice to the first rail and fix with 6pcs screws (3pcs each side), then insert rail splice to the second rail and make sure 2pcs rails are tightly close and flat, lastly fixing the 6pcs screws.

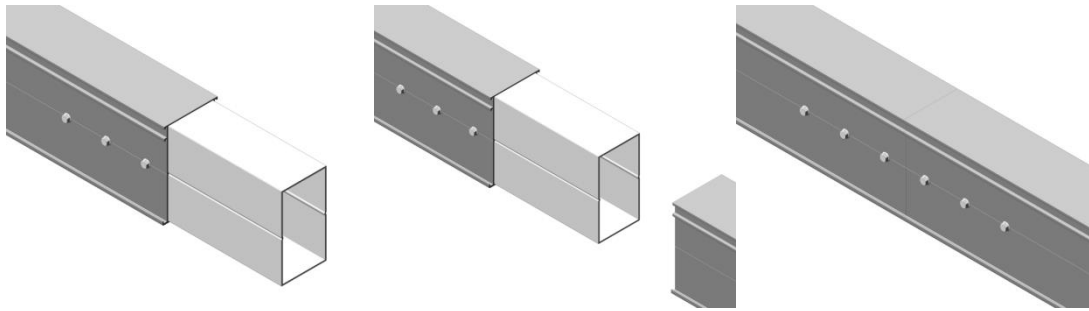

Position of screws:

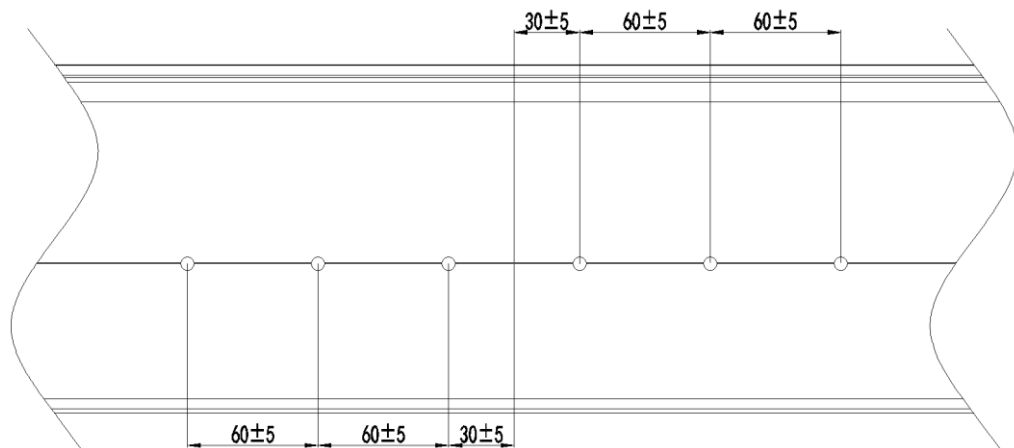

(Front View)

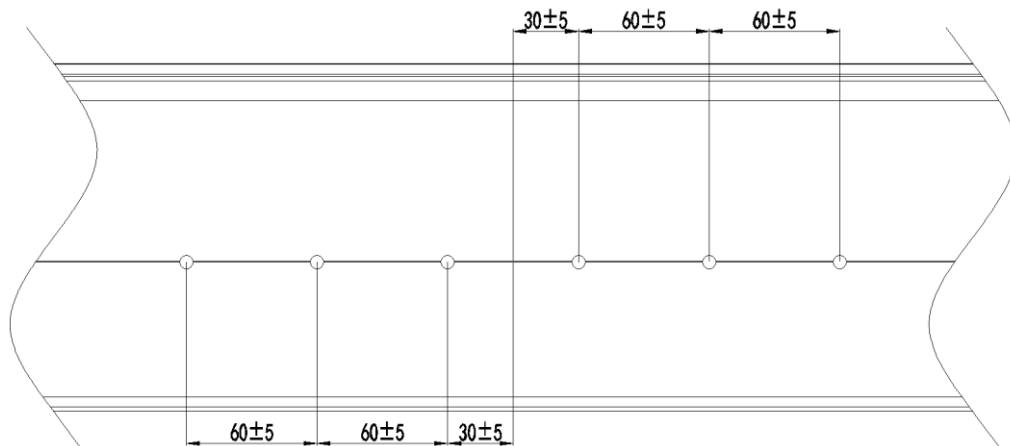

(Back View)

#### 4.2. Fixing the rails on beams by 4pcs rail clamp (2pcs each side)

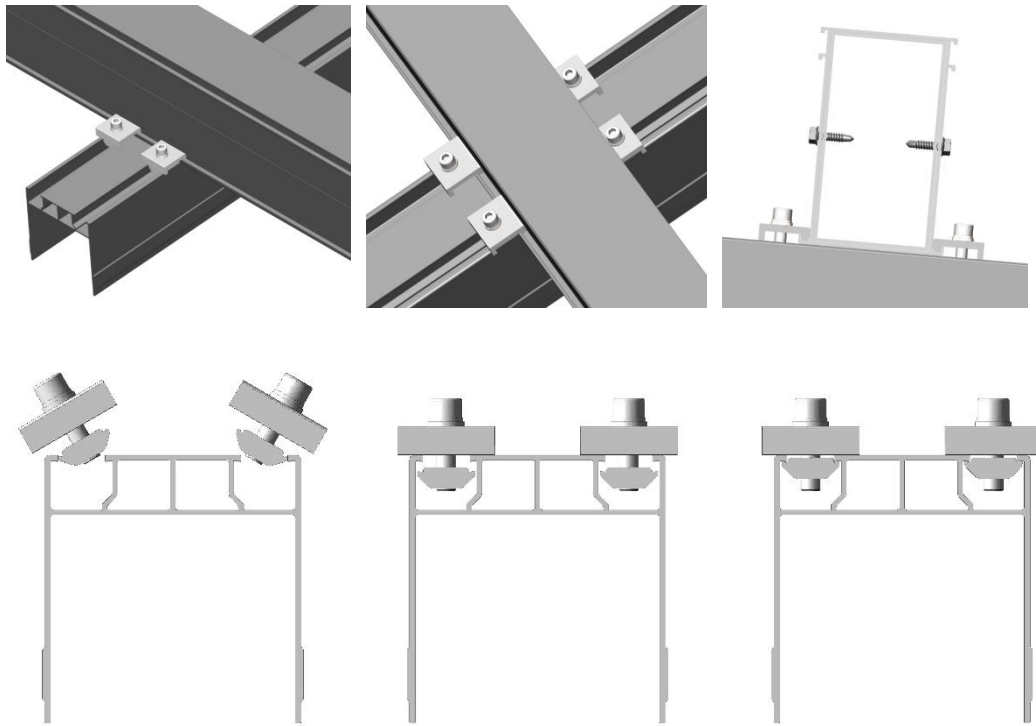

Repeat above steps to install the other rails according to the drawing, and make sure all bolts are tightened.

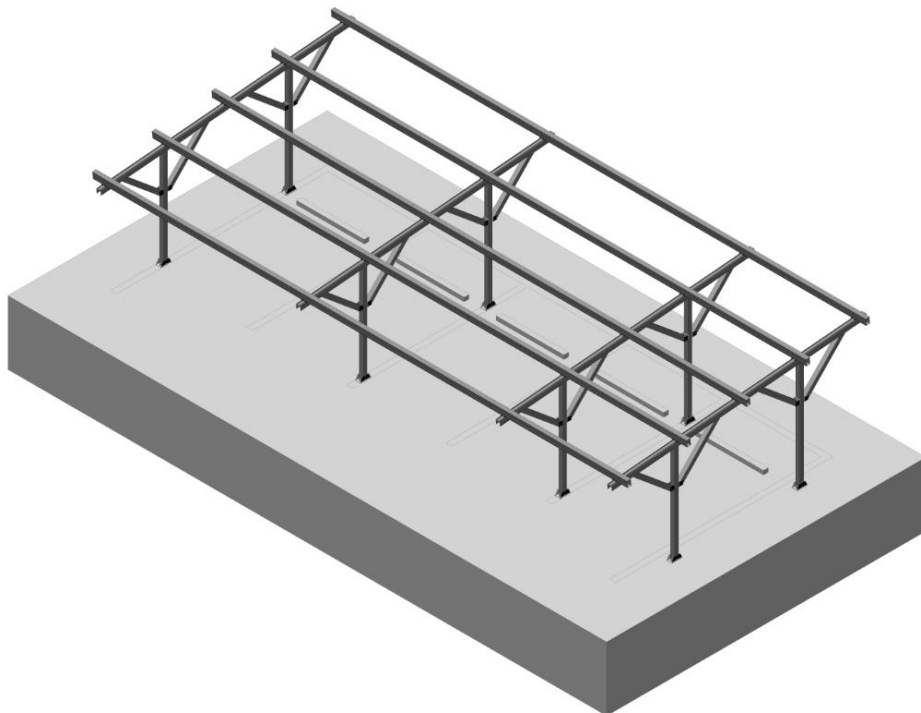

## 5. Installation of Water Guiding Rail

### 5.1. Connecting 2pcs W rail

(Skip this step if the rail is long enough)

Insert 2pcs rail splices to the first W rail and fixing 2pcs screws on left and right side, and insert the other half of rail splices to the second W rail also fixing 2pcs screws on each side.

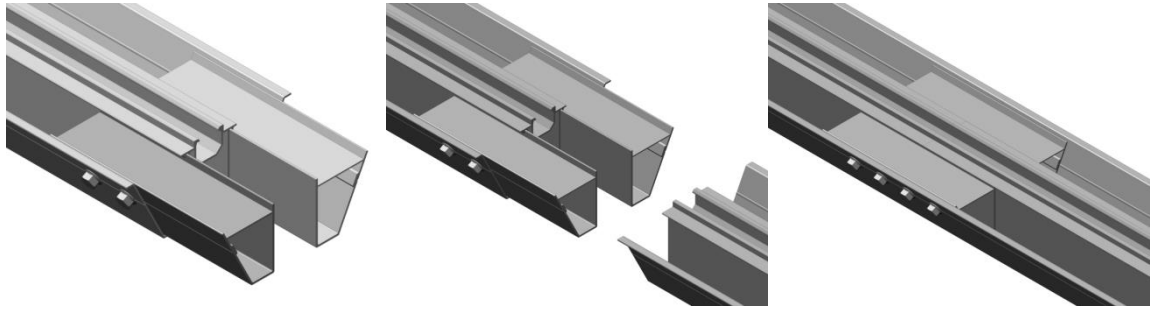

5.2. Please use structural sealant on the connecting positions of 2pcs W rail (below in red).

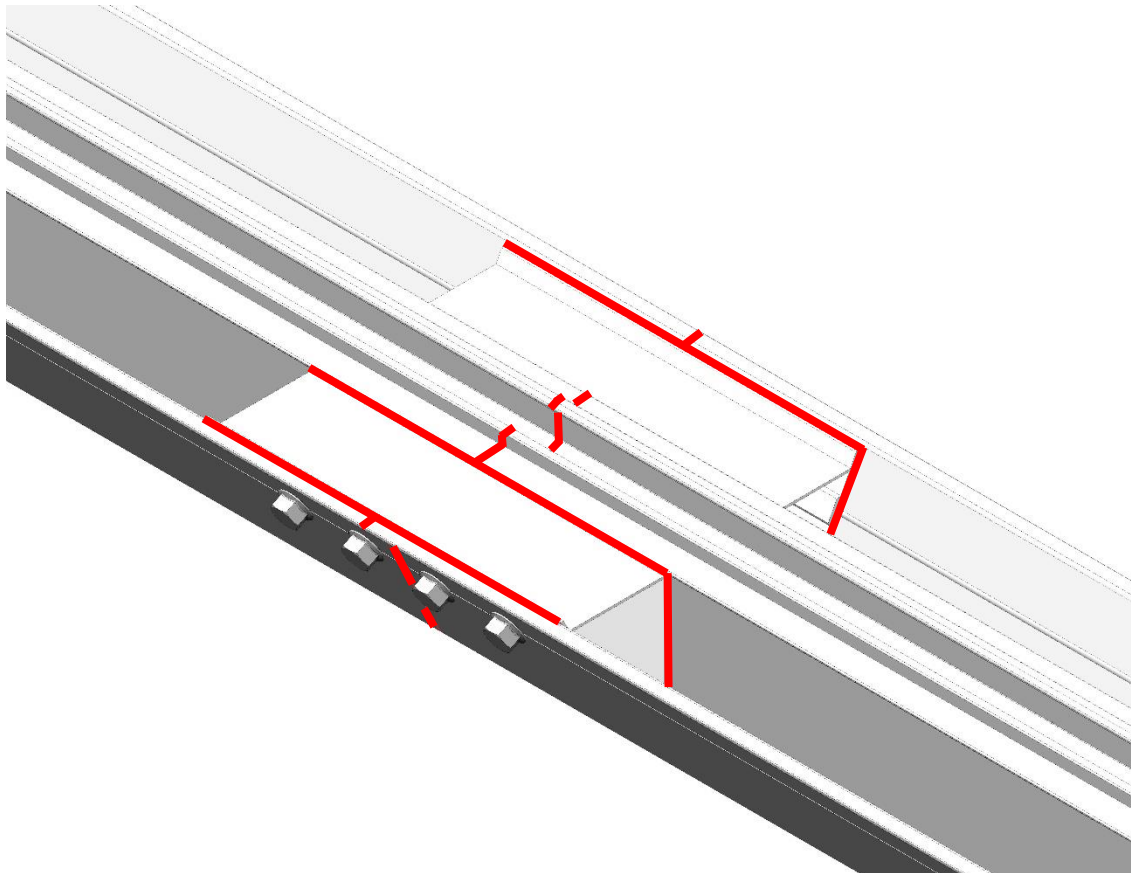

*Layout of using sealant (red mark)*

5.3. Fixing W rail on the bottom rail by 2pcs W rail clamps (1pc each side)

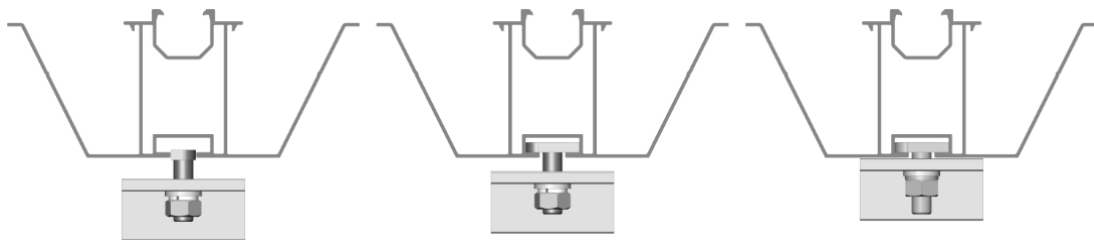
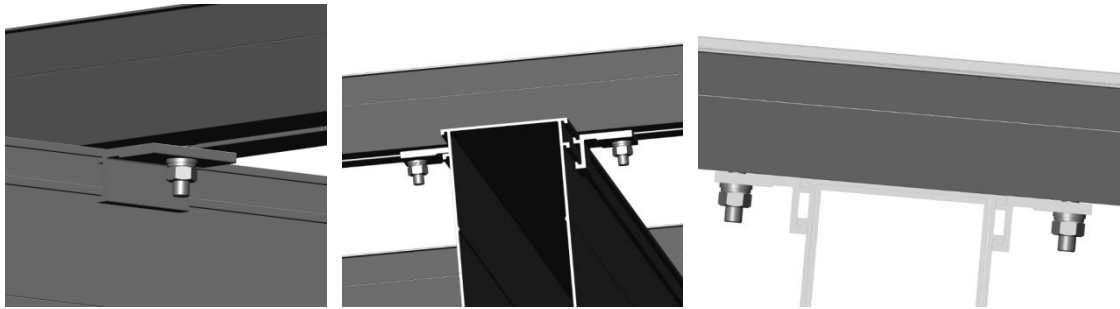

*Connecting W rail on bottom rail  
(Note the orientation of T bolt head)*

5.4 Follow the above steps to install the other W rails according to the shop drawing and tighten the bolts.

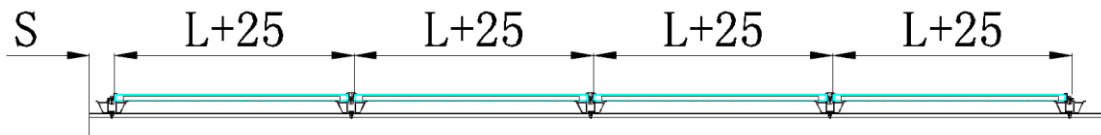

*Layout of W rail (L=panel width, S=gap to the end of bottom rail)*

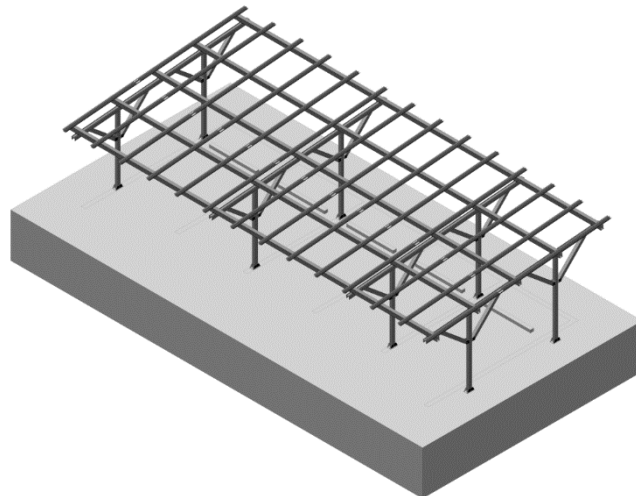

*Layout of structure after above installation*

## 6. Installation of Module

6.1 As shown in the figure below, place the horizontal water guiding channel on the corresponding position of the two adjacent waterproof W rails, that is, the middle position of the two adjacent modules in vertical direction.

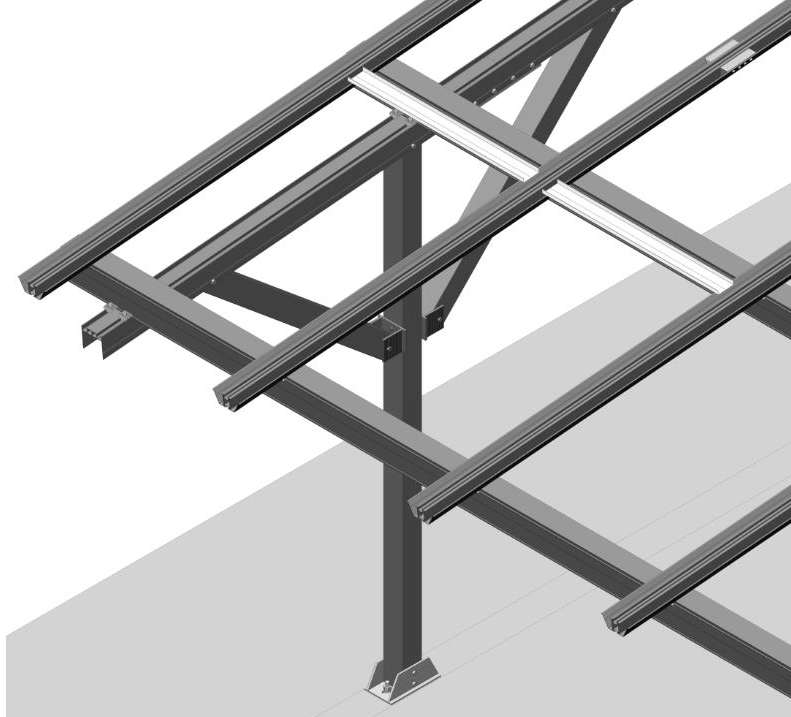

6.2 Place the module on the W rails, and the lower end is flush with the lower end of the W rail. It is recommended to install from bottom to top and from left to right. The adjacent positions of the upper and lower modules need to snap the aluminum frame on the back of the module into the installed horizontal water channel, in order to achieve the effect that the horizontal water channel is installed between the upper and lower adjacent modules.

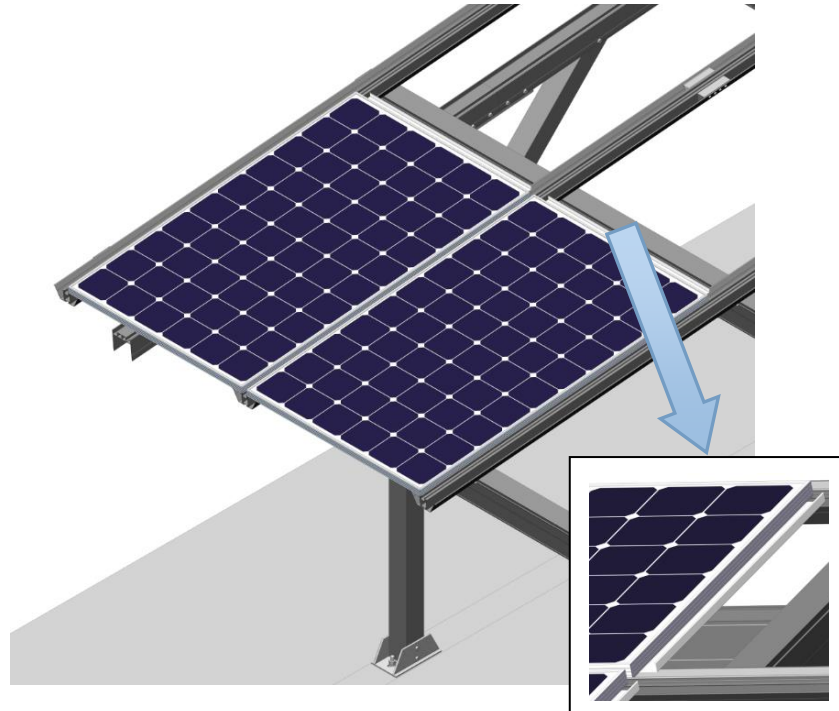

### 6.3 Using module clamps to fix modules.

#### a. Installation of End Clamp

Screw the nut to the end of the bolt, and then place the nut sideways into the rail slot.

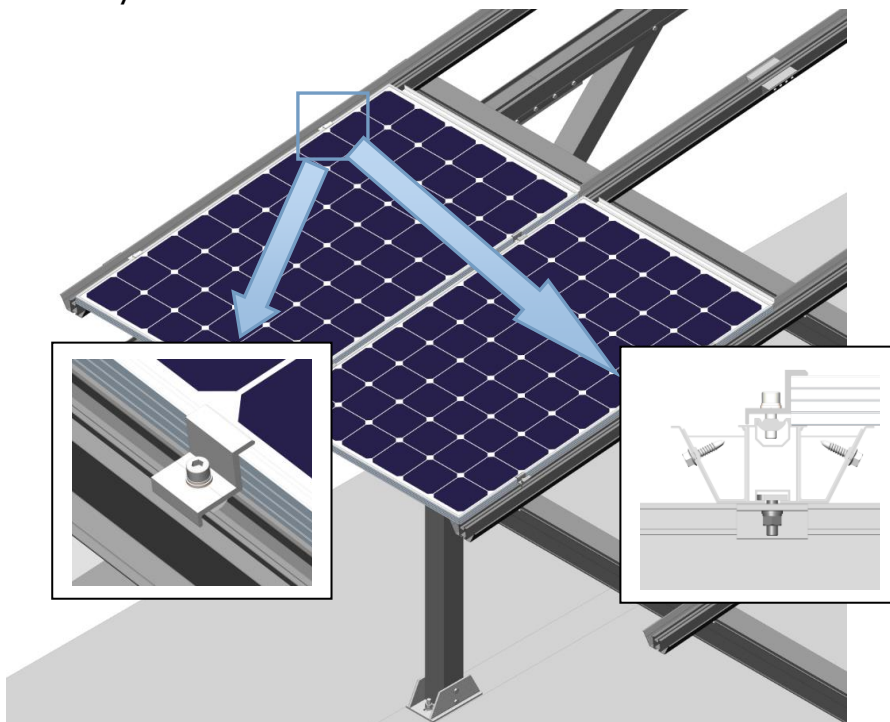

#### b. Installation of Mid Clamp

Screw the nut to the end of the bolt, and then place the nut sideways into the rail slot.



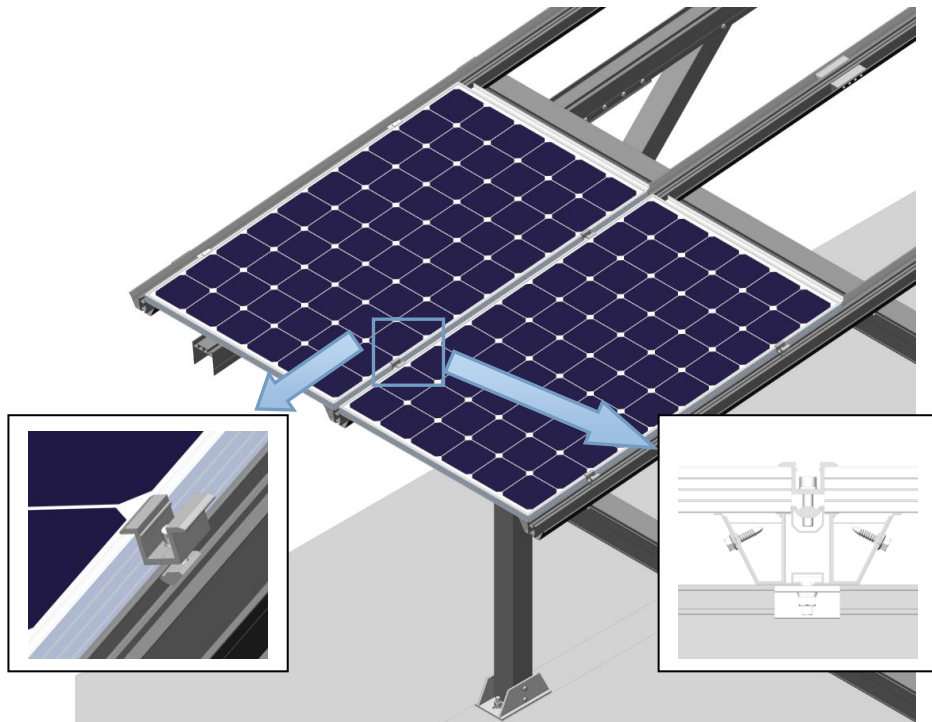

- c. Place all modules and fix it with module clamps.  
 ©Please make sure the modules and rails should be tightly closed.  
 (Allowable gap  $\leq 3\text{mm}$ )

Module clamps installation			
End clamp			
Mid clamp			

**【Notice】 :**  
 ©The positions of module clamps should refer to the requirements from module supplier.

6.4 Please place the rubber string on the gap of 2pcs nearing modules (up and down), which means above the horizontal water guiding channel, and suggest to push 2pcs modules (up and down) to be tightly closed.

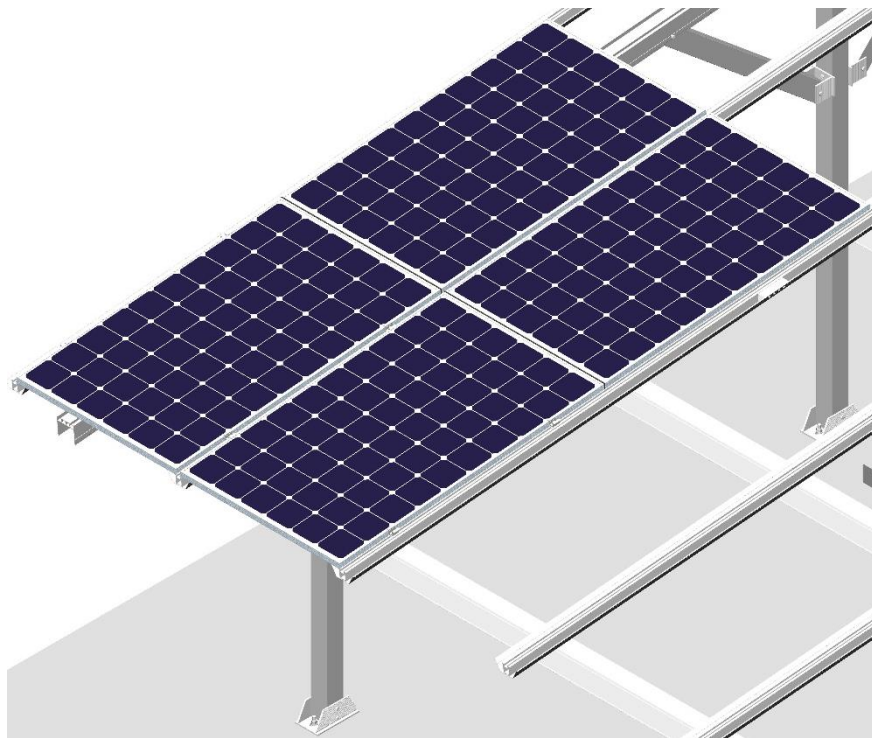
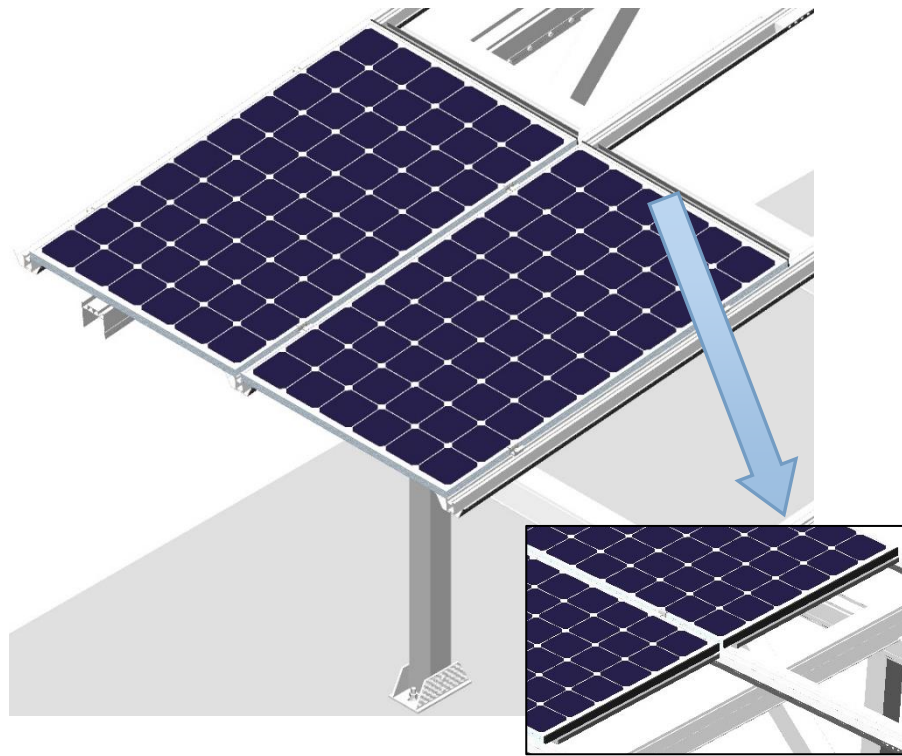

6.5 Repeat above steps to install the rest modules according to the shop drawing. And do not miss the water guiding channels and rubber strings.

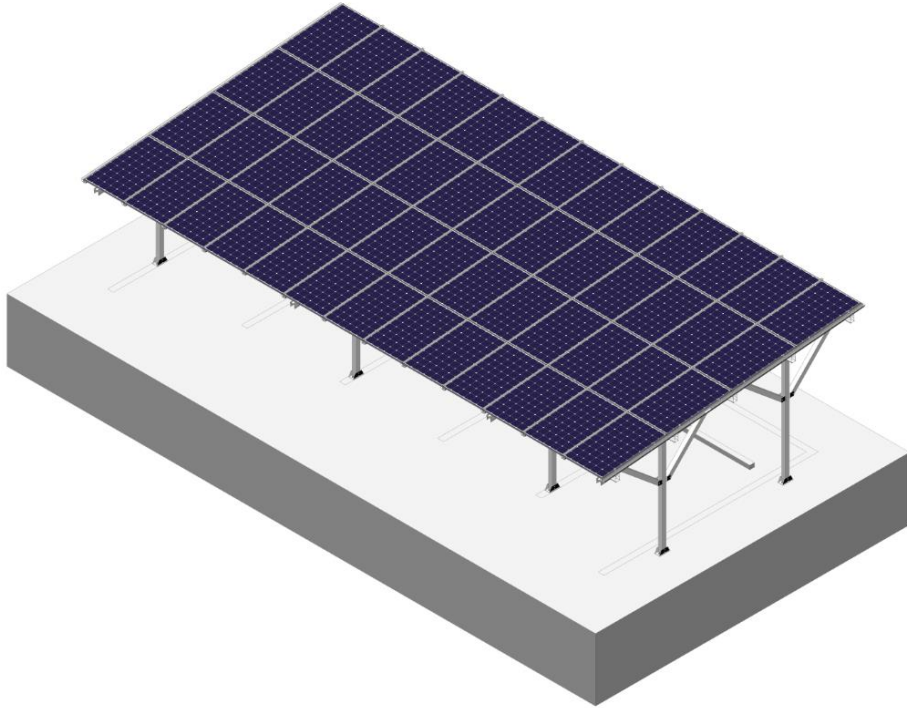

*completion of installing modules*

## 7. Installation of W Rail Top Cover

7.1 Place the top covers on the top of mid clamps and push it into W rails.

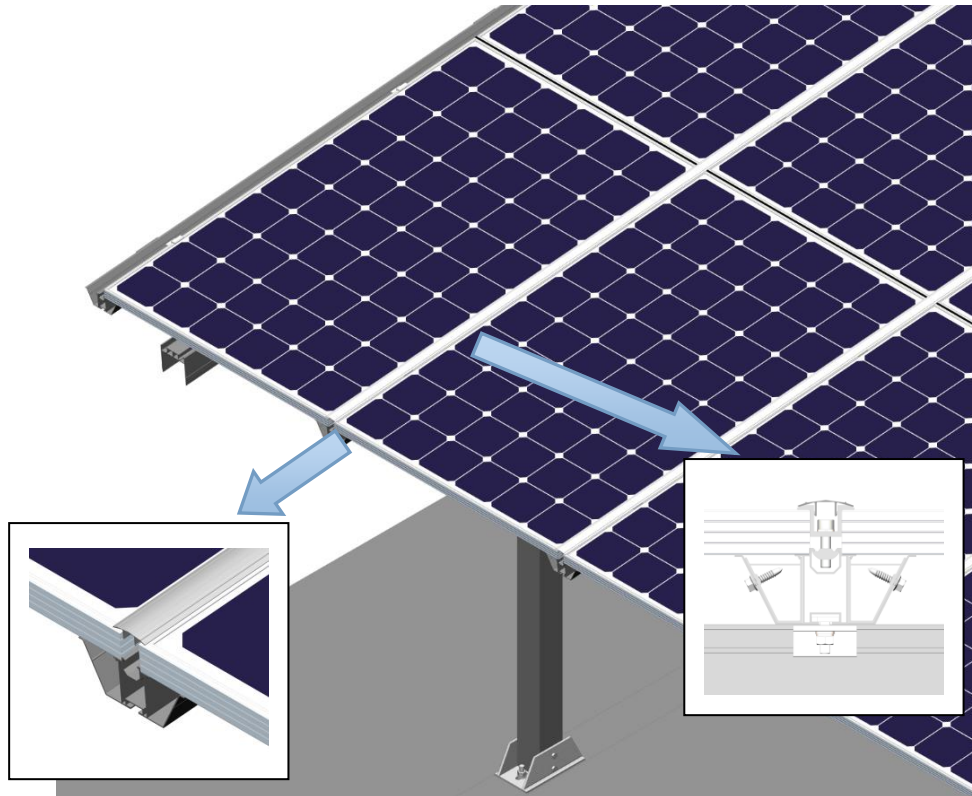

Repeat above steps to fix the rest top covers

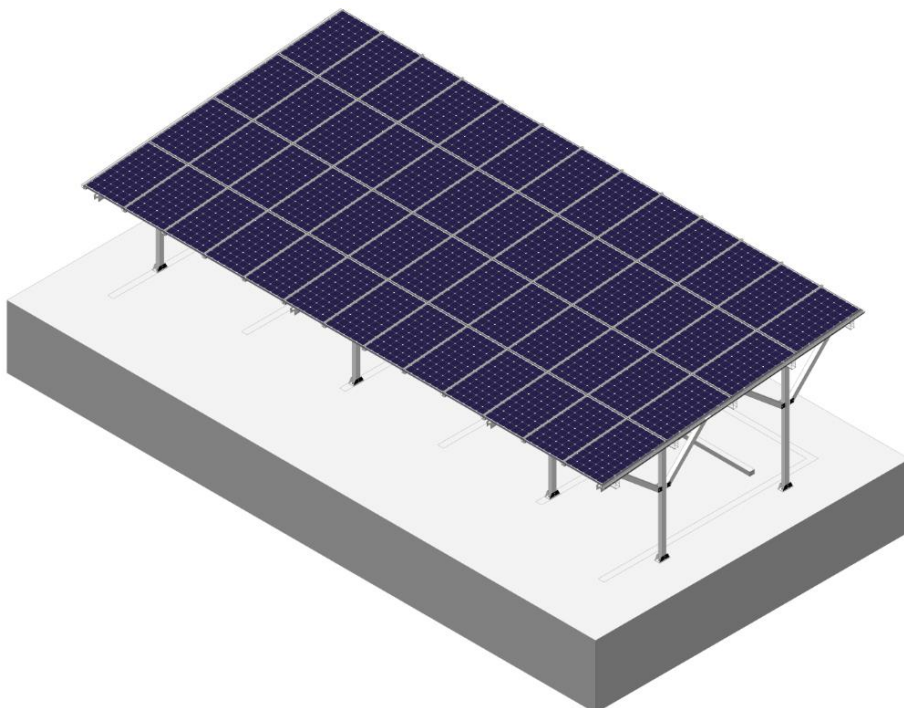

## 8. Each View of Complete Installation

*Front View*

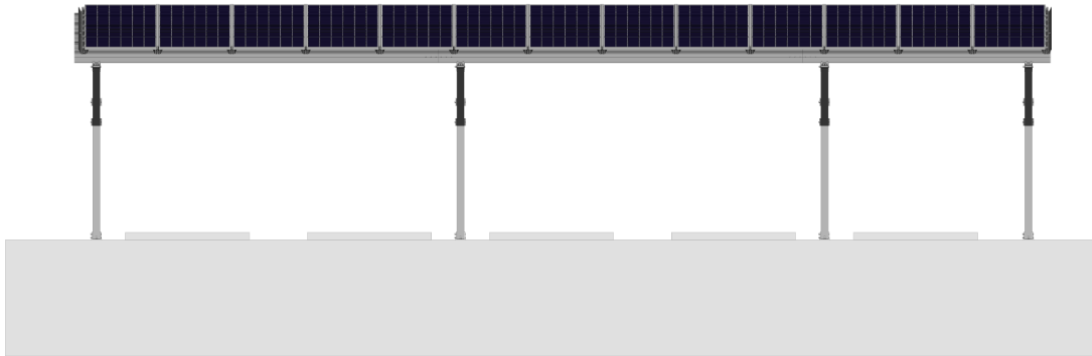

*Rear View*

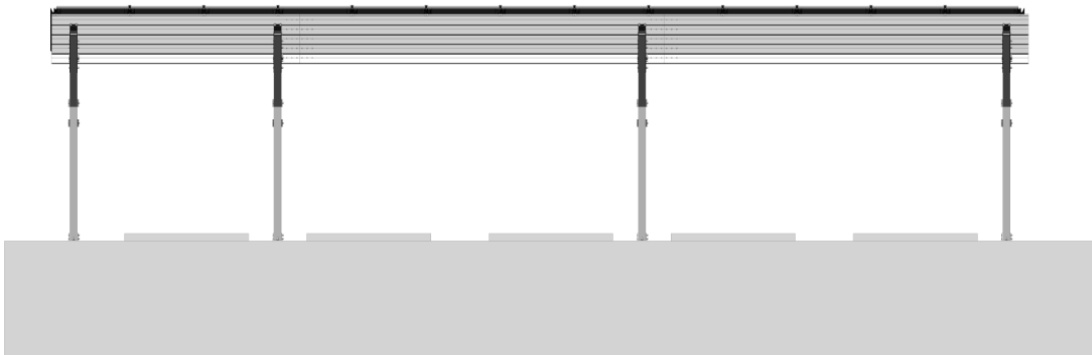

*Side View*

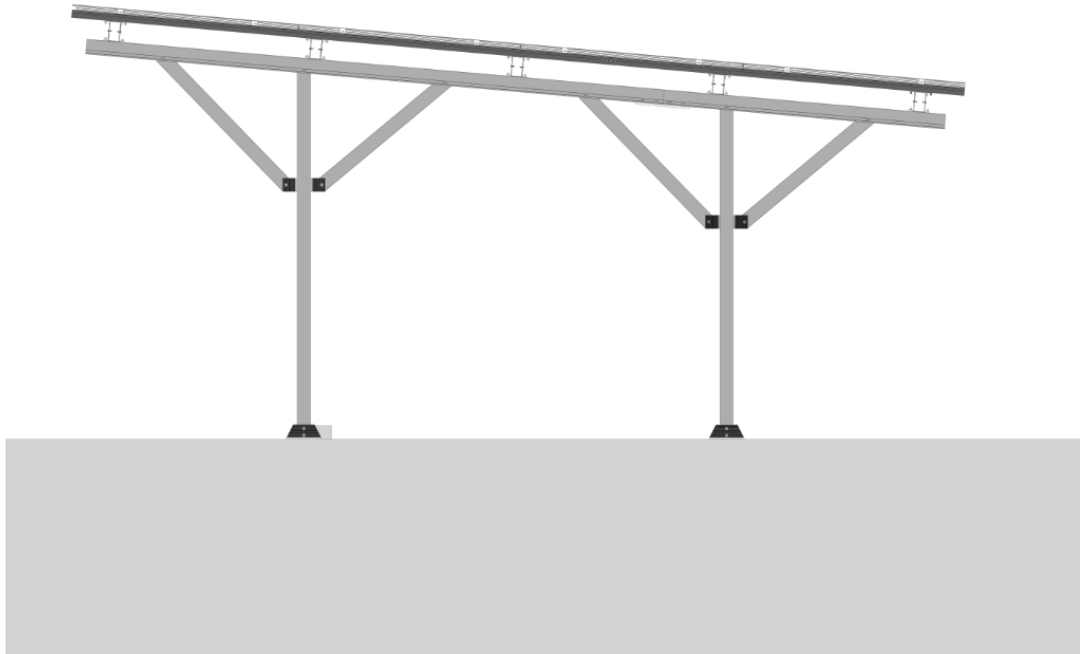

*Top View*

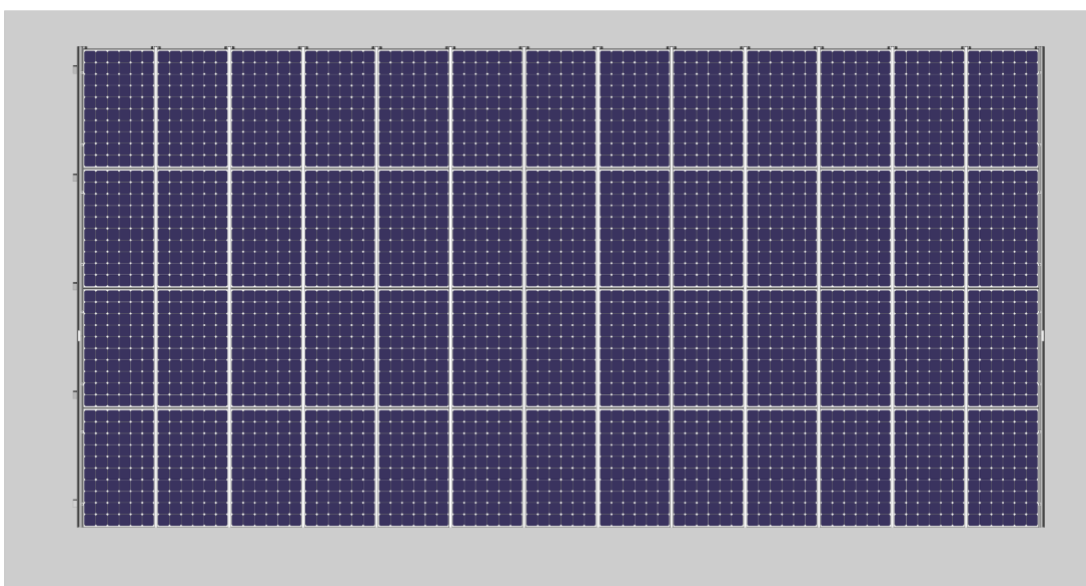

## VI. Notice

### 1. Notes for Construction Dimension

The specific dimensions of all installations involved are subject to the construction drawings. This installation instruction is only for the description of the product installation method.

### 2. Notes for Stainless Steel Fasteners

Because of the good ductility for stainless steel, the fasteners have big difference with carbon steel one in nature. If use in improper way, it will result in bolt and nut being "locked", which commonly known as "seizure". Prevention from lock basically has the following ways:

#### 2.1. Reduce the Friction Coefficient

(1) Ensure that the bolt thread surface is clean and tidy (No dust, grit, etc.);

(2) It is recommended to use yellow wax or lubricant during installation (such as lubricating grease, 40# engine oil, which are prepared by users).

#### 2.2. Correct Operation Method

(1) The bolt must be perpendicular to the axis of the thread, and not inclined (Do not tighten Obliquely);

(2) In the process of tightening, the strength needs to be balanced, tightening torque shall not exceed the prescribed safety torque value;

(3) Choose torque wrench or socket wrench as far as possible, avoid using adjustable wrench or electric wrench. Lower the rotating speed while have to use electric wrenches;

(4) Avoid using electric wrenches etc. under high temperature conditions, do not rotate fast when using, to avoid rapid rise in temperature and cause "seizure".



#### **HQ Add**

30F, W Square, 1801 Huandao East Road  
Siming District, Xiamen, China

#### **Production Base Add**

Guanshan Industrial Park  
Changtai County, Zhangzhou, China

#### **Website**

[www.antisolar.com](http://www.antisolar.com)